

## SafeBag RDS

Secure deposit and storage of valuables

SafeBag RDS (Rotary Deposit System) is designed for the fast, secure and convenient deposit of valuables into a safe. The unit is fitted to the top of the safe and deposits can be made via the front (for a stand-alone installation) or at the rear (for a through-the-wall installation).

The deposit opening is designed to take special cassettes as well as standard envelopes. Deposits are made via a protective drum into a lockable compartment or self-sealing bag inside the safe. SafeBag RDS has been constructed to match the burglary protection provided by safes in Grades I-III.

# SafeBag RDS

Secure deposit and storage of valuables

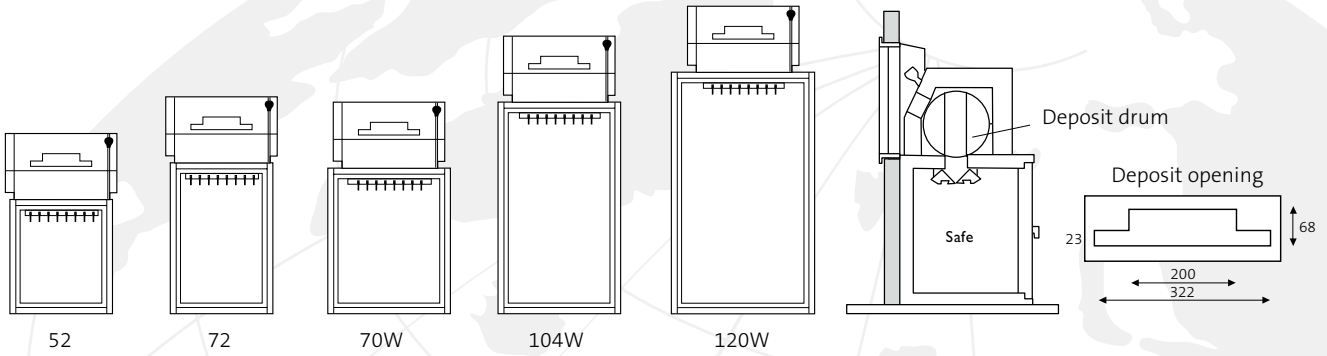

## Deposit

The deposit system consists of a deposit head and rotating drum. The deposit head can be installed to suit front access for a stand-alone unit or rear access for a through-the-wall deposit facility. The rotating drum – easily operated by a handle at the front – provides protection from attempted burglary and a secure deposit procedure. The deposit opening is designed to allow special cassettes as well as A5 and A4 deposit envelopes. As options a lockable deposit compartment combined with other interior fittings are available including self-sealing bags in 3 different sizes.

## Burglary protection

SafeBag RDS is constructed to the same standards as Grade I–III safes certified in accordance with the European norm, EN 1143-1. The rotating drum also has an anti-fishing guard to prevent the contents of the safe being reached via the deposit slot. All models can be bolted to the floor using a powerful anchoring kit.

## Locking

All models are delivered with a key lock as standard on the safe door. For dual locking, an optional electronic lock can be fitted. A key lock may also be fitted to the deposit mechanism in order to control the release of the drum.

## Quality and environmental management systems

SafeBag RDS deposit systems are manufactured in accordance with ISO 9001 for Quality Management Systems and ISO 14001 for Environmental Management Systems.

Product Data											
Model	External dimensions (mm)			Internal dimensions (mm)			Weight (kgs)			Vol. (lit)	
	Atlantic RDS	Height	Width*	Depth	Height	Width	Depth	Grade I	II		III
52		950	555	490	525	460	329	395	420	455	80
72		1150	555	490	725	460	329	465	502	535	110
70W		1125	655	571	700	560	410	560	600	665	160
104W		1470	655	571	1045	560	410	654	682	759	240
120W		1630	765	620	1205	670	459	820	880	960	370

\* Deposit head width is 590 in all models

### Interior fittings

 **Fixed shelf max 50kg**  
 For 52–72\*  
 Size 10x450x295  
 For 70W–104W\*  
 Size 10x550x376  
 For 120W\*  
 Size 10x660x425

 **Lockable compartments**  
**Int. height 150mm**  
 For 52–72  
 Size 145x393x256

 **Int. height 200mm**  
 For 70W–104W  
 Size 195x493x337  
 For 120W  
 Size 195x603x386

 **Int. height 300mm**  
 For 52–72  
 Size 295x393x256

\* Also available reinforced, max 120 kg

### Deposit fittings

 **Security bag for CIT employees**

 **Deposit cassette**

 **Lockable deposit cassette**

 **Deposit envelope**

We reserve the right to alter product information without any obligation.